

MQ-090/092 BRONZE WRAPPED(FB series) Bushing



FB-1



FB-2



FB-3

MQ-090 Bronze-Wrapped Bushings

MQ-090 bronze wrapped bushing, using tin bronze alloy CuSn8P/CuSn6.5P for material, Surface rolling diamond pockets, to store grease or graphite powder, to rapidly build up a lubrication film at the start of movement and thereafter reduce the startup & running friction;

it has good fatigue strength and bearing capacity, corrosion resistance, wear resistance.

Widely used in agricultural machinery, forestry machinery, building machinery, construction machinery, such as high load low speed occasions.

(also known as FB090 or B09)



Product Benefits

- 1.the advantages of light weight and low cost,for compact application,easy fitting;
- 2.oil pockets stored oil or grease, then the time for apply oil is extended over 5 times than the ones of general copper sleeve;
- 3 extremely high bearing capacity, especially can match the shafts with rough surfaces;
- 4 high heat dissipation, small expansion coefficient, stable use, long service life
- 5.Excellent wear resistance with lower friction;
- 6.Chemical resistance.

Chemical Composition

Material	Cu	Sn	P
CuSn8	91.3%	8.5%	0.3%

Refer to the standard of DIN17662

ISO 4382-2: 1991; CW453K

The actual composition proportion is allowed to up or down in certain range

Application case



widely used in elevator, conveyor, hoist, agricultural machinery, forestry machinery, etc., etc..

Technical Data

Max.Loading	Static	120N/mm ²
	Dynamic load	40N/mm ²
Max.PV limit	Grease lubrication	2.8N/mm ² ·m/s
Max.Speed		2.5m/s
Match the axis	Hardness	≥50HRC
	Roughness	Ra=0.4~1.0
Friction Coefficient		0.05~0.25 μ
Tensile strength		470N/mm ²
Yield Strength		280N/mm ²
Hardness		100~120HB
Density		8.8g/cm ³
Temperature Range		-100°C~+200°C
Thermal conductivity		58 W(m·k) ⁻¹
Coefficient of thermal expansion		18.5 × 10 ⁻⁶ ·K ⁻¹

*Initial pre-lubrication at assembly is required.

Material Structure

Use high density bronze strips to roll the spherical oil pockets, in order to reduce wear, prolong the use time, good corrosion and protection function

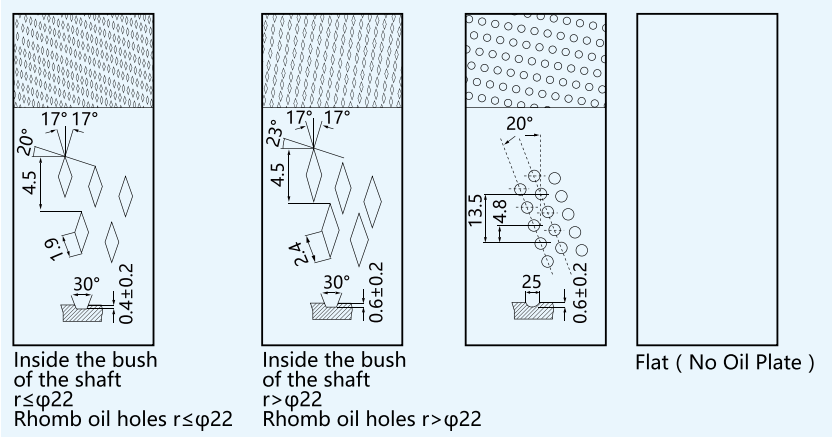

MQ-092 Bronze-Wrapped Bushings

MQ-092 wrapped bronze bushing, using tin bronze alloy CuSn8/CuSn6.5 for material, with oil holes according to a certain angle, easy to form oil film at startup, thereby reducing startup & running friction coefficient.

It has good bearing capacity, corrosion resistance and wear resistance.

This series of products are widely used in agricultural machinery, forestry machinery, construction machinery, construction machinery and other high load low speed occasions.

(also known as FB092)



Product Benefits

- 1.the advantages of light weight and low cost,for compact application,easy fitting;
- 2.oil holes stored more oil or grease, then extended service life and lubrication intervals than normal MQ-090 type bushings.
- 3 high bearing capacity, especially can match the shafts with rough surfaces;
- 4 extraemely high heat dissipation, small expansion coefficient, stable use, long service life
- 5.Excellent wear resistance with lower friction;
- 6.Chemical resistance.

Chemical Composition

Material	Cu	Sn	P
CuSn8	91.3%	8.5%	0.3%

Refer to the standard of DIN17662
ISO 4382-2: 1991; CW453K

The actual composition proportion is allowed to up or down in certain range

Application case



widely used in agricultural machinery, forest machinery, construction machinery, etc.

Technical Data

Max.Loading	Static	120N/mm ²
	Dynamic load	40N/mm ²
Max.PV limit	Grease lubrication	2.8N/mm ² ·m/s
Max.Speed		2.5m/s
Match the axis	Hardness	≥50HRC
	Roughness	Ra=0.4~1.0
Friction Coefficient		0.05~0.25 μ
Tensile strength		470N/mm ²
Yield Strength		280N/mm ²
Hardness		100~120HB
Density		8.8g/cm ³
Temperature Range		-100°C~+200°C
Thermal conductivity		58 W(m·k) ⁻¹
Coefficient of thermal expansion		18.5 × 10 ⁻⁶ ·K ⁻¹

*Initial pre-lubrication at assembly is required.

Material Structure

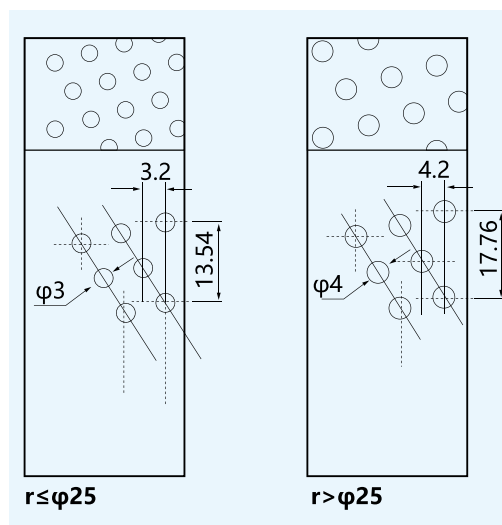

The oil holes can be filled with grease before or after the assembly, in order to facilitate the formation of the transfer film, reducing Friction Coefficient. The utility model has the advantages of large oil storage capacity and long maintenance free period.

MQ-09G Embed Graphites Bronze-Wrapped Bushings

MQ-09G are similar to the MQ090, except there are solid lubricants embedded into the diamond shaped pockets on the bearing surface, which provide perfect lubrication at the startup & running, even with a lack of oil.

It can be used in construction machinery, gear boxes, automotive clutch parts, forestry machinery, etc.

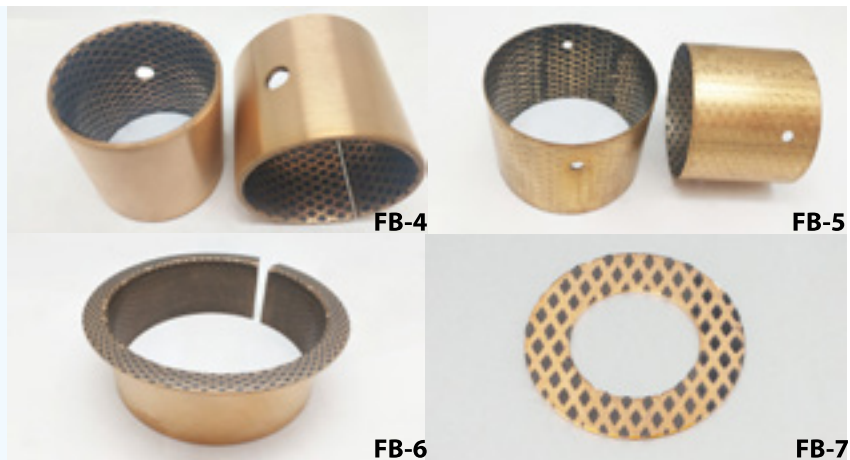

*Initial pre-lubrication at assembly is required.

MQ-08G Embed Graphites Steel-Wrapped Bushings

MQ-08G is similar with the MQ09G, except for: replace bronze with steel backing, to save the costs, economic & more loading capacity.

Widely used in construction machinery, machine and machine tool, brake system of automobile, etc.

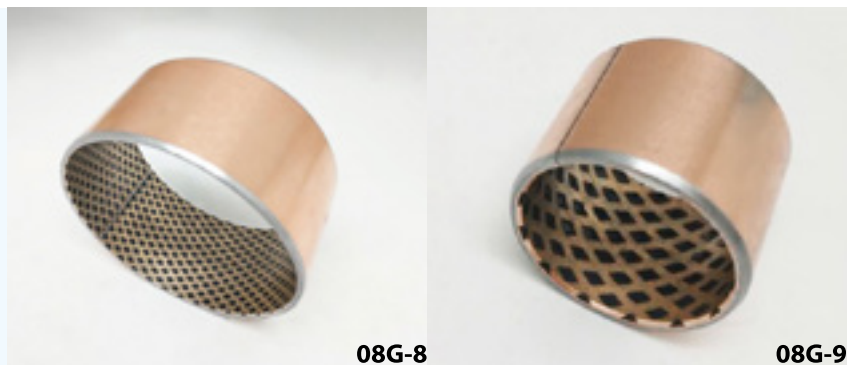

*Initial pre-lubrication at assembly is required.

MQ-091 Brass-Wrapped Bushings

MQ-091 is similar with MQ090, except for: replace bronze with copper CuZn31Si(H68) or CuZn37Si(H62), to save the costs, economic & more loading capacity.

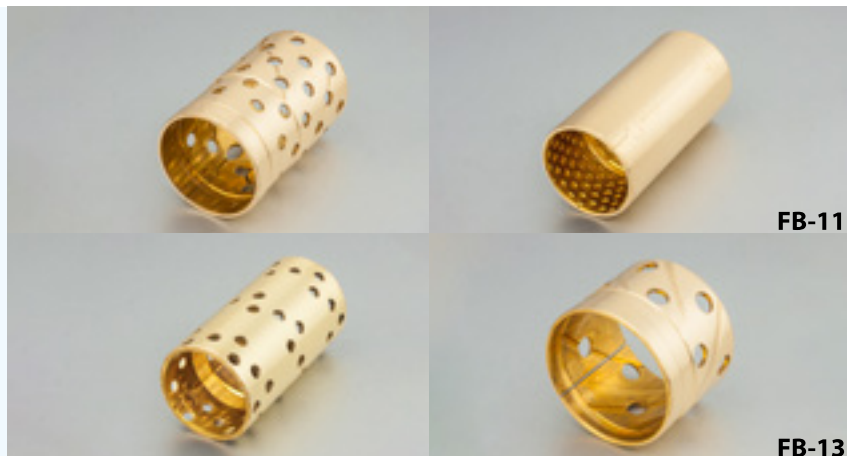

* Initial pre-lubrication at assembly is required.

MQH-090/092 Bronze-Wrapped Bushings (Super Hardness)

MQH-090/092 : compared to the normal MQ090/092,with higher Hardness;the corresponding bearing capacity and wear resistance are stronger, to adapt to a wider range of products, longer service life.

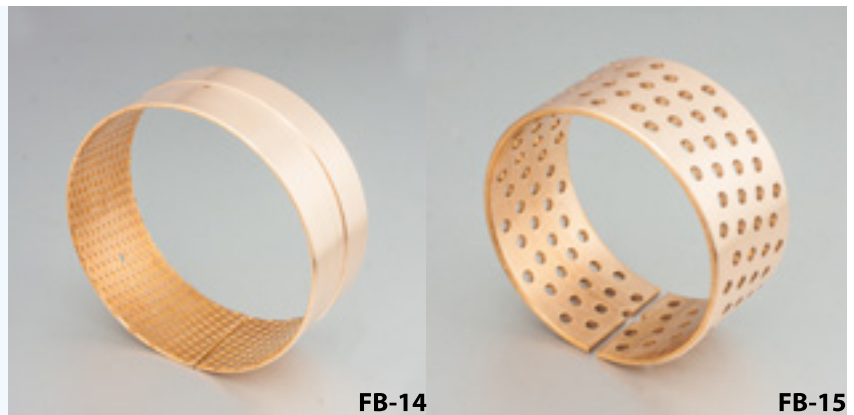

*Initial pre-lubrication at assembly is required.

Technical Data	MQH-090/092	MQ-090/092
Tensile strength, Rm	680N/mm ²	450N/mm ² .m/s
Max.Speed	2.5m/s	2.5m/s
Yield Strength, Rp 0.2	200N/mm ²	250N/mm ²
Hardness, Brinell	140-165HB	100~120HB
Friction Coefficient	0.03~0.2 μ	0.05~0.25 μ
Max Static load	120~180N/mm ²	80~120N/mm ²
Max Dynamic load	45~60N/mm ²	30~40N/mm ²
Surface Roughness	2 μ m	2 μ m

Standard tolerance for MQ-090/092 series bushing (As per to DIN 1494/ ISO3547)

Standard Dia.	O.D.Size	Housing Bore(H7)	I.D.Size after mounting (H9)	Matching Shaft Diameter (f7 to f8)
10~18	+0.065 +0.030	+0.018 0	+0.046 0	- 0.016 - 0.043
18~30	+0.075 +0.035	+0.021 0	+0.052 0	- 0.020 - 0.020
30~50	+0.085 +0.045	+0.025 0	+0.062 0	- 0.025 - 0.064
50~80	+0.100 +0.055	+0.030 0	+0.074 0	- 0.030 - 0.076
80~120	+0.120 +0.070	+0.035 0	+0.087 0	- 0.036 - 0.090
120~180	+0.170 +0.100	+0.400 0	+0.100 0	- 0.043 - 0.106
180~250	+0.210 +0.130	+0.046 0	+0.115 0	- 0.050 - 0.122
250~315	+0.260 +0.170	+0.052 0	+0.130 0	- 0.056 - 0.137

Available type

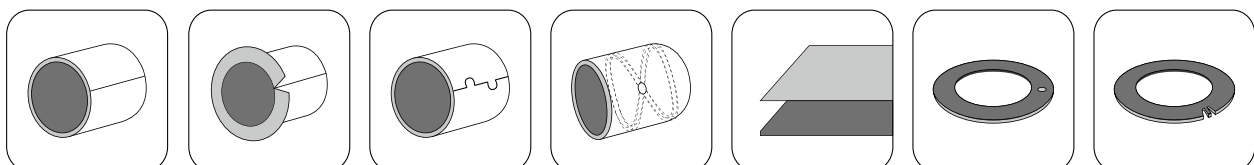

MQ-090/092 Series Bronze-Wrapped Bushings (Parts)



MQ-090/MQ-092 Series Bronze-Wrapped Bushings Specification

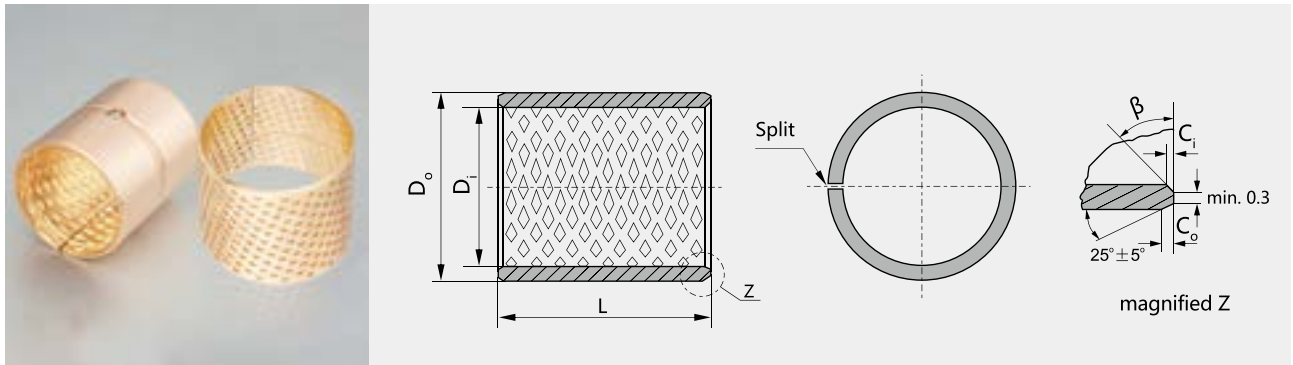

available if need

ID and OD chamfers

S_3	C_o	C_i	β
0.75	0.5 ± 0.3	0.25 ± 0.2	$35^\circ \pm 5^\circ$
1.00	0.6 ± 0.3	0.30 ± 0.2	$35^\circ \pm 5^\circ$
1.50	0.7 ± 0.3	0.50 ± 0.3	$35^\circ \pm 5^\circ$

S_3	C_o	C_i	β
2.00	1.2 ± 0.4	0.50 ± 0.3	$35^\circ \pm 5^\circ$
2.50	1.8 ± 0.6	0.60 ± 0.3	$45^\circ \pm 5^\circ$

Unit: mm

D_i ϕd	D_o ϕD	Length L ± 0.40													
		10	15	20	25	30	35	40	50	60	70	80	90	100	
10	12	1010	1015	1020											
12	14	1210	1215	1220											
14	16	1410	1415	1420	1425										
15	17	1510	1515	1520	1525										
16	18	1610	1615	1620	1625										
18	20	1810	1815	1820	1825										
20	23	2010	2015	2020	2025										
22	25	2210	2215	2220	2225	2230									
24	27		2415	2420	2425	2430									
25	28		2515	2520	2525	2530									
28	31		2815	2820	2825	2830									
30	34		3015	3020	3025	3030	3035	3040							
32	36		3215	3220	3225	3230	3235	3240							
35	39		3515	3520	3525	3530	3535	3540							
40	44			4020	4025	4030	4035	4040	4050						
45	50			4520	4525	4530	4535	4540	4550						
50	55			5020	5025	5030	5035	5040	5050	5060					
55	60			5520	5525	5530	5535	5540	5550	5560					
60	65				6025	6030	6035	6040	6050	6060	6070				
65	70					6530	6535	6540	6550	6560	6570				
70	75					7030	7035	7040	7050	7060	7070	7080			
75	80					7530	7535	7540	7550	7560	7570	7580			
80	85					8030	8035	8040	8050	8060	8070	8080			



MQ-090/MQ-092 Series Bronze-Wrapped Bushings Specification

D _i φ d	D _o φ D	Length L $\begin{smallmatrix} 0 \\ -0.40 \end{smallmatrix}$									
		25	30	35	40	50	60	70	80	90	100
85	90		8530	8535	8540	8550	8560	8570	8580	8590	
90	95		9030	9035	9040	9050	9060	9070	9080	9090	
95	100				9540	9550	9560	9570	9580	9590	95100
100	105					10050	10060	10070	10080	10090	100100
105	110					10550	10560	10570	10580	10590	105100
110	115					11050	11060	11070	11080	11090	110100
115	120					11550	11560	11570	11580	11590	115100
120	125						12060	12070	12080	12090	120100
125	130						12560	12570	12580	12590	125100
130	135						13060	13070	13080	13090	130100
135	140						13560	13570	13580	13590	135100
140	145						14060	14070	14080	14090	140100
145	150						14560	14570	14580	14590	145100
150	155						15060	15070	15080	15090	150100
155	160						15560	15570	15580	15590	155100
160	165						16060	16070	16080	16090	160100
165	170						16560	16570	16580	16590	165100
170	175						17060	17070	17080	17090	170100
175	180						17560	17570	17580	17590	175100
180	185						18060	18070	18080	18090	180100
185	190						18560	18570	18580	18590	185100
190	195						19060	19070	19080	19090	190100
195	200						19560	19570	19580	19590	195100
200	205						20060	20070	20080	20090	200100
205	210						20560	20570	20580	20590	205100
215	220						21560	21570	21580	21590	215100
225	230						22560	22570	22580	22590	225100
230	235						23060	23070	23080	23090	230100
240	245						24060	24070	24080	24090	240100
250	255						25060	25070	25080	25090	250100
260	265						26060	26070	26080	26090	260100
270	275						27060	27070	27080	27090	270100
280	285						28060	28070	28080	28090	280100
290	295						29060	29070	29080	29090	290100
300	305						30060	30070	30080	30090	300100

Non-standard dimensions & tolerances are available

MQ-090F/MQ-092F Series Bronze Flange Bushing Specification

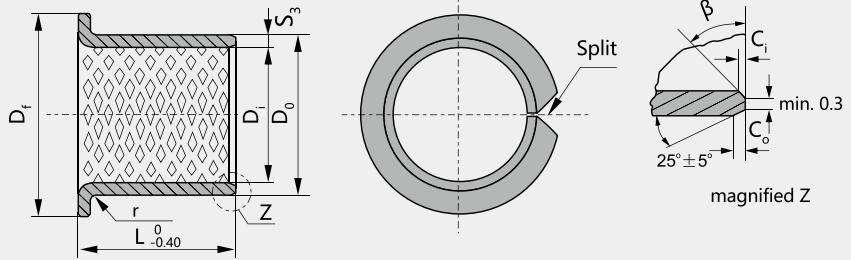

available if need

S_3	1.0	1.5	2.0	2.5
r	$1^{+0.5}$	1 ± 0.5	1.5 ± 0.5	2 ± 0.5

Unit: mm

D_i ϕd	D_o ϕD	D_f	Length L 0.40																				
			15	20	25	30	35	40	50	60	70	80	90										
25	28	35	25150	25200	25250																		
30	34	45		30200	30250	30300																	
35	39	50		35200	35250	35300	35350																
40	44	55			40250	40300	40350	40400															
45	50	60				45300	40350	40400	40500														
50	55	65				50300	50350	50400	50500														
55	60	70				55300	55350	55400	55500														
60	65	75				60300	60350	60400	60500	60600													
65	70	80				65300	65350	65400	65500	65600													
70	75	85					70350	70400	70500	70600	70700												
75	80	90					75350	75400	75500	75600	75700												
80	85	100					80350	80400	80500	80600	80700	80800											
90	95	110							90500	90600	90700	90800	90900										
100	105	120							100500	100600	100700	100800	100900										
110	115	130							110500	110600	110700	110800	110900										
120	125	140							120500	120600	120700	120800	120900										
130	135	155								130600	130700	130800	130900										
140	145	165								140600	140700	140800	140900										
150	155	180								150600	150700	150800	150900										
160	165	190								160600	160700	160800	160900										
170	175	200								170600	170700	170800	170900										
180	185	215								180600	180700	180800	180900										
190	195	225								190600	190700	190800	190900										
200	205	235								200600	200700	200800	200900										
225	230	260								225600	225700	225800	225900										
250	255	290								250600	250700	250800	250900										
265	270	305								265600	265700	265800	265900										
285	290	325								285600	285700	285800	285900										
300	305	340								300600	300700	300800	300900										